

CS742

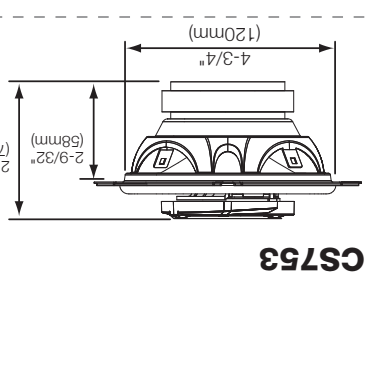

CS753

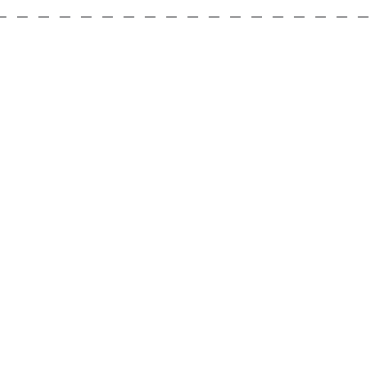
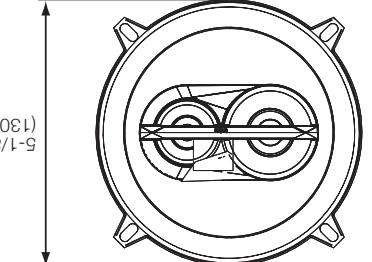

CS766

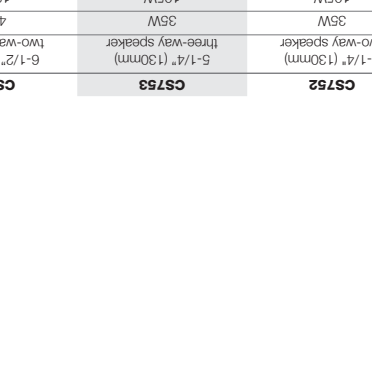
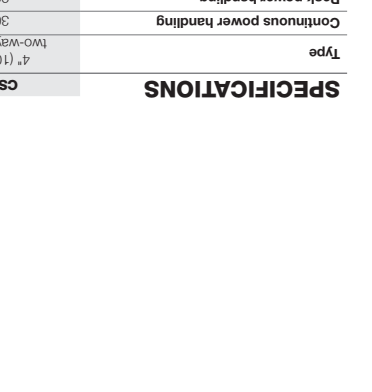

CS782

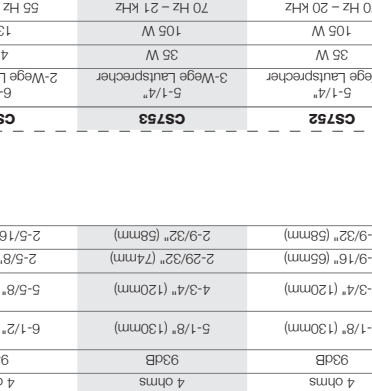
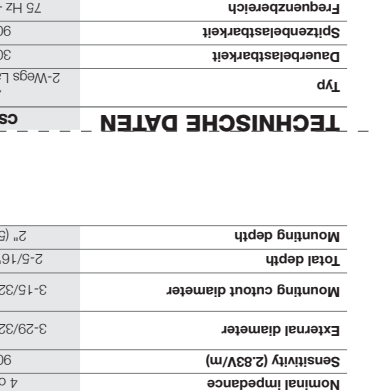

CS798

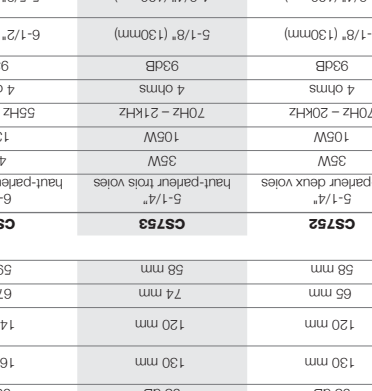

CS814

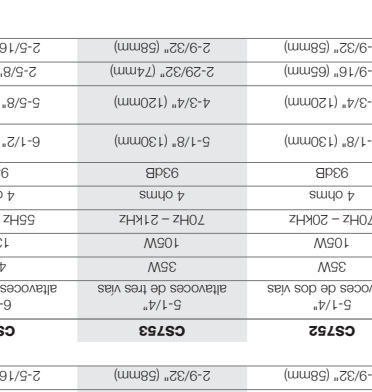
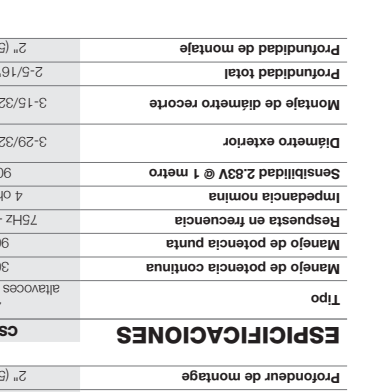

CS830

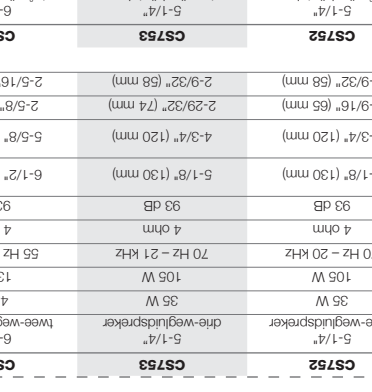

CS846

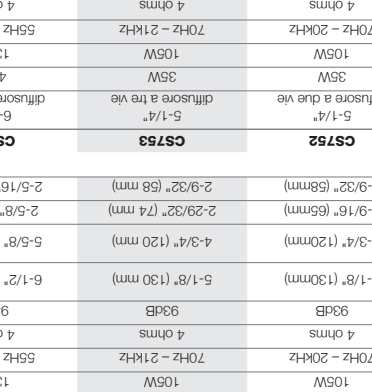

CS862

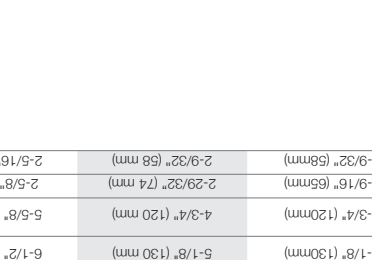
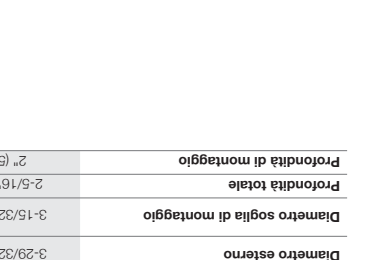

CS878

SPECIFICATIONS

Table with 2 columns: Specification name and values for models CS742, CS752, CS763, CS776, CS782, CS792, CS798, CS808, CS814, CS830, CS846, CS856, CS862, CS872, CS878.

TECHNISCHE DATEN

Table with 2 columns: Specification name and values for models CS742, CS752, CS763, CS776, CS782, CS792, CS798, CS808, CS814, CS830, CS846, CS856, CS862, CS778, CS788.

ESPECIFICACIONES

Table with 2 columns: Specification name and values for models CS742, CS752, CS763, CS776, CS782, CS792, CS798, CS808, CS814, CS830, CS846, CS856, CS862, CS778, CS788.

SPECIFICATIONS

Table with 2 columns: Specification name and values for models CS742, CS752, CS763, CS776, CS782, CS792, CS798, CS808, CS814, CS830, CS846, CS856, CS862, CS778, CS788.

TECHNISCHE DATEN

Table with 2 columns: Specification name and values for models CS742, CS752, CS763, CS776, CS782, CS792, CS798, CS808, CS814, CS830, CS846, CS856, CS862, CS778, CS788.

SPECIFICATIONS

Table with 2 columns: Specification name and values for models CS742, CS752, CS763, CS776, CS782, CS792, CS798, CS808, CS814, CS830, CS846, CS856, CS862, CS778, CS788.

СПЕЦИФИКАЦИИ

Table with 2 columns: Specification name and values for models CS742, CS752, CS763, CS776, CS782, CS792, CS798, CS808, CS814, CS830, CS846, CS856, CS862, CS778, CS788.

TECHNISCHE DATEN

Table with 2 columns: Specification name and values for models CS742, CS752, CS763, CS776, CS782, CS792, CS798, CS808, CS814, CS830, CS846, CS856, CS862, CS778, CS788.

ESPECIFICACIONES

Table with 2 columns: Specification name and values for models CS742, CS752, CS763, CS776, CS782, CS792, CS798, CS808, CS814, CS830, CS846, CS856, CS862, CS778, CS788.

SPECIFICATIONS

Table with 2 columns: Specification name and values for models CS742, CS752, CS763, CS776, CS782, CS792, CS798, CS808, CS814, CS830, CS846, CS856, CS862, CS778, CS788.

TECHNISCHE DATEN

Table with 2 columns: Specification name and values for models CS742, CS752, CS763, CS776, CS782, CS792, CS798, CS808, CS814, CS830, CS846, CS856, CS862, CS778, CS788.

SPECIFICATIONS

Table with 2 columns: Specification name and values for models CS742, CS752, CS763, CS776, CS782, CS792, CS798, CS808, CS814, CS830, CS846, CS856, CS862, CS778, CS788.

СПЕЦИФИКАЦИИ

Table with 2 columns: Specification name and values for models CS742, CS752, CS763, CS776, CS782, CS792, CS798, CS808, CS814, CS830, CS846, CS856, CS862, CS778, CS788.